

1

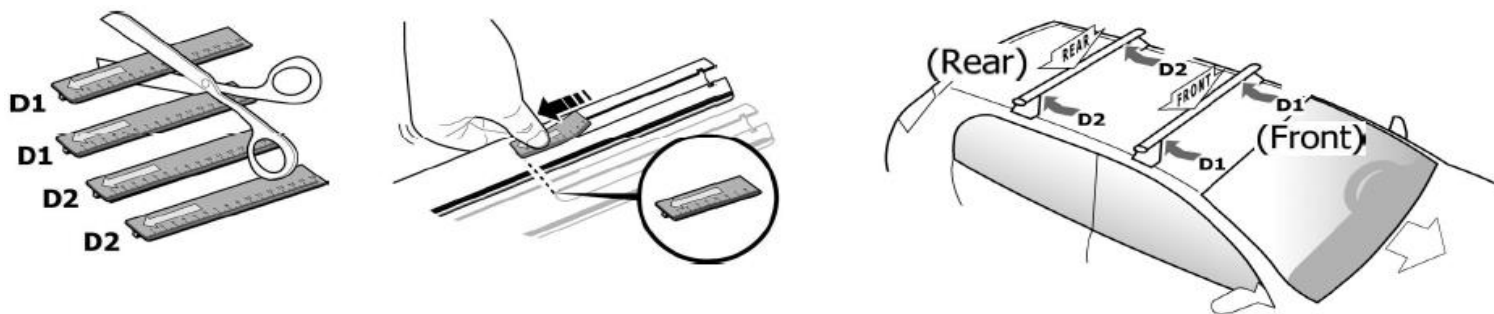

MANUFACTURER	MODEL CAR	DOORS	MODEL YEAR	D1	D2
RENAULT	Clio Collection	5	12>16	9,8	7,1
RENAULT	Clio III	5	05>12	9,8	7,1
RENAULT	Gran Modus	5	07>13	6,4	3,8
RENAULT	Modus	5	04>13	6,4	3,8

2

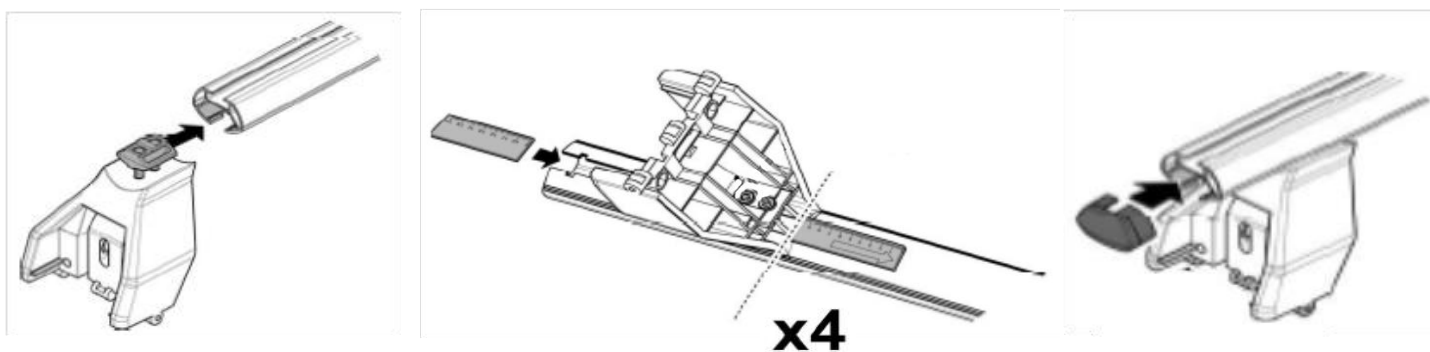

3

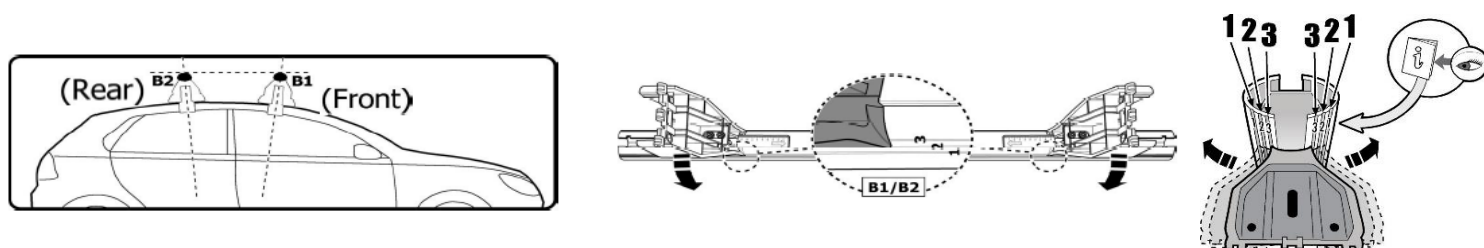

MANUFACTURER	MODEL CAR	DOORS	MODEL YEAR	B1	B2
RENAULT	Clio Collection	5	12>16	2	2
RENAULT	Clio III	5	05>12	2	2
RENAULT	Gran Modus	5	07>13	2	2
RENAULT	Modus	5	04>13	2	2

4

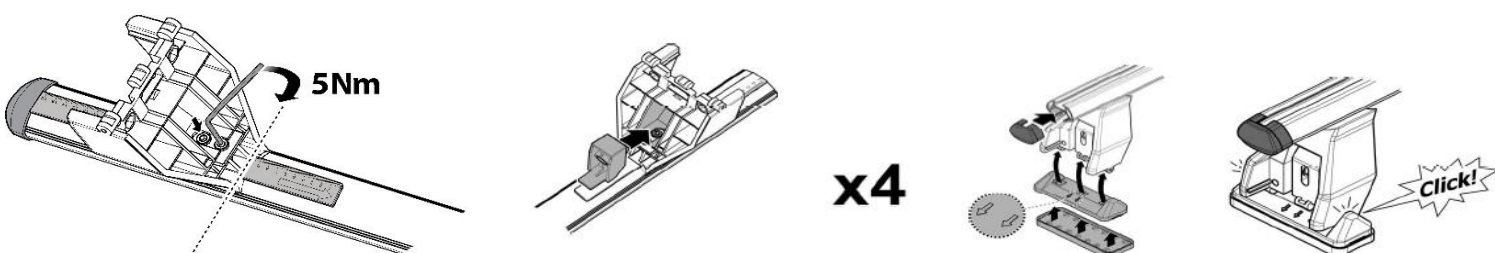

5

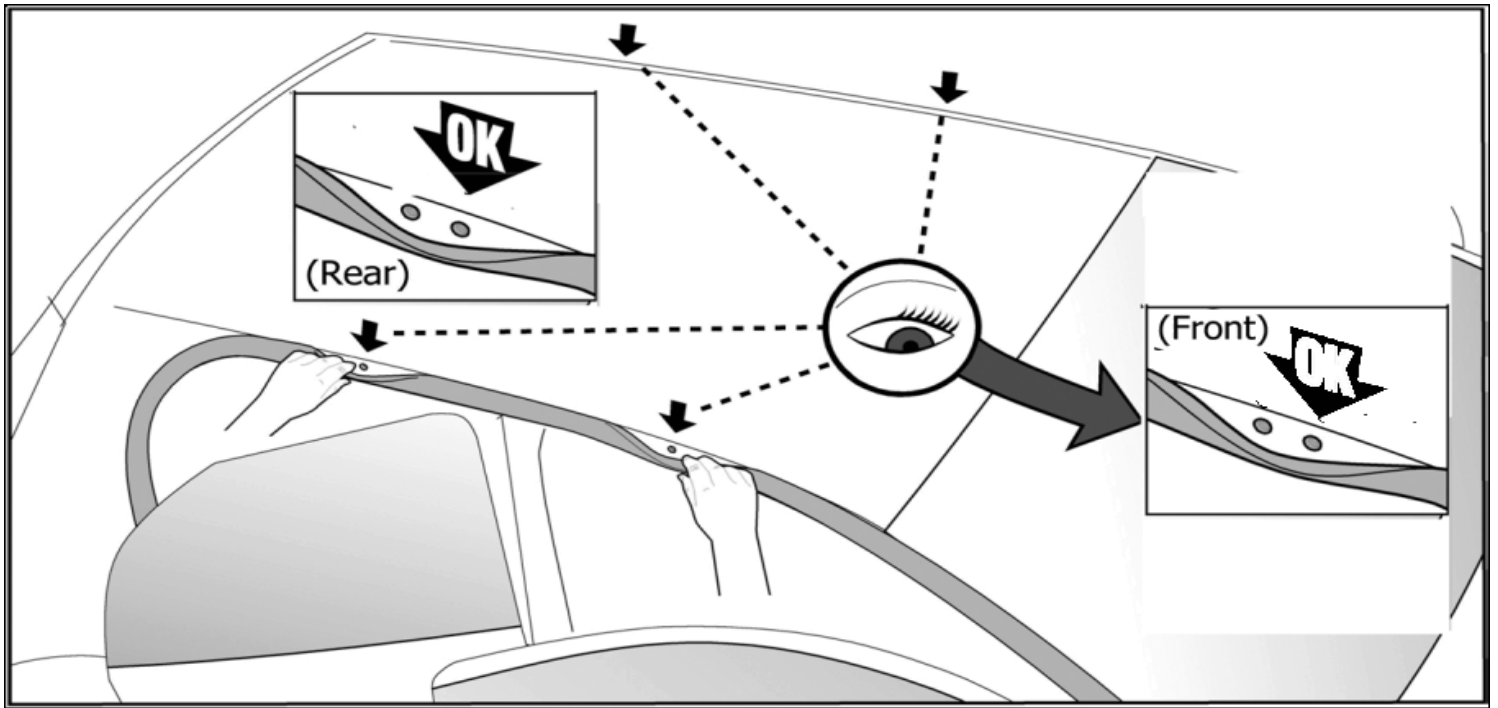

6

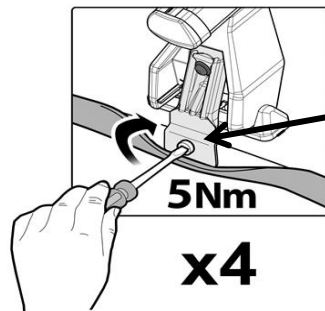
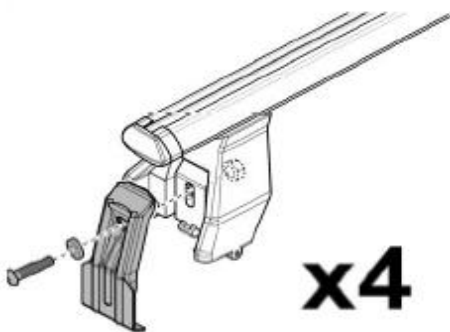
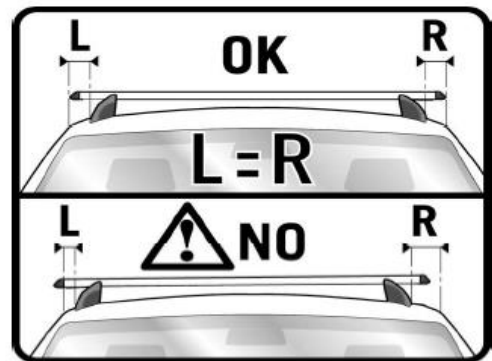
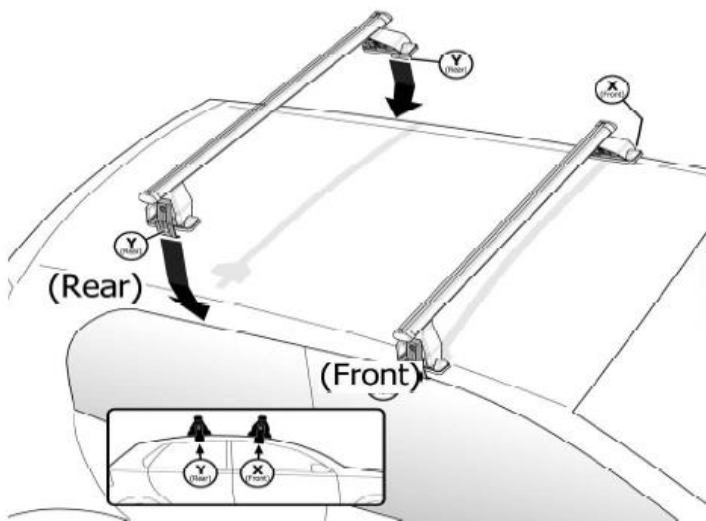

4 $\oplus 8 \times 15$ include
- included