

1

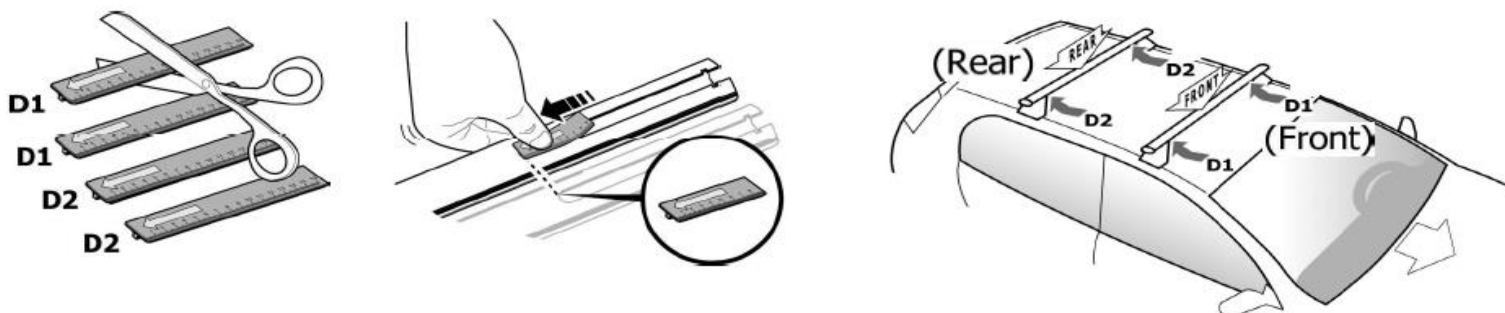

MANUFACTURER	MODEL CAR	DOORS	MODEL YEAR	D1	D2
FIAT	Punto I	3	93>99	9,1	11,8

2

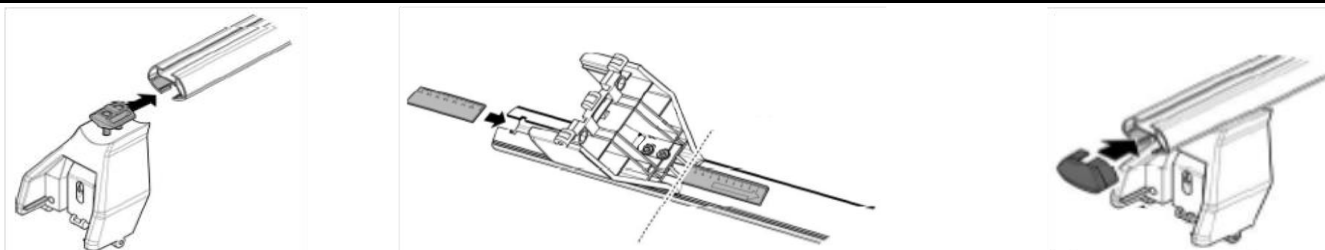

x4

3

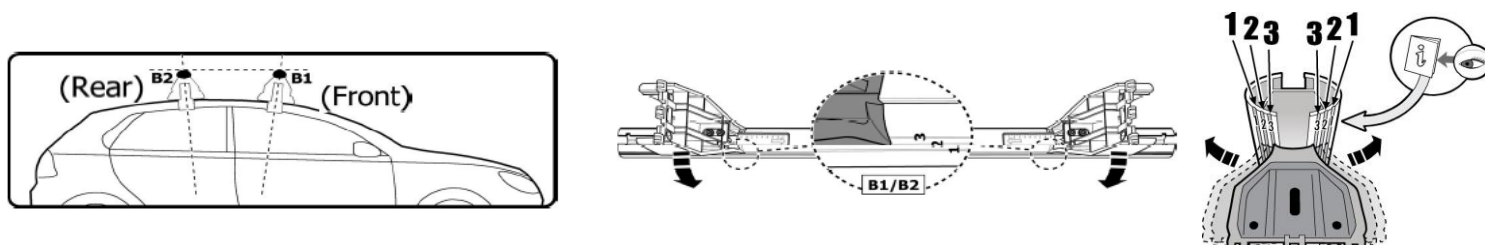

MANUFACTURER	MODEL CAR	DOORS	MODEL YEAR	B1	B2
FIAT	Punto I	3	93>99	2	2

4

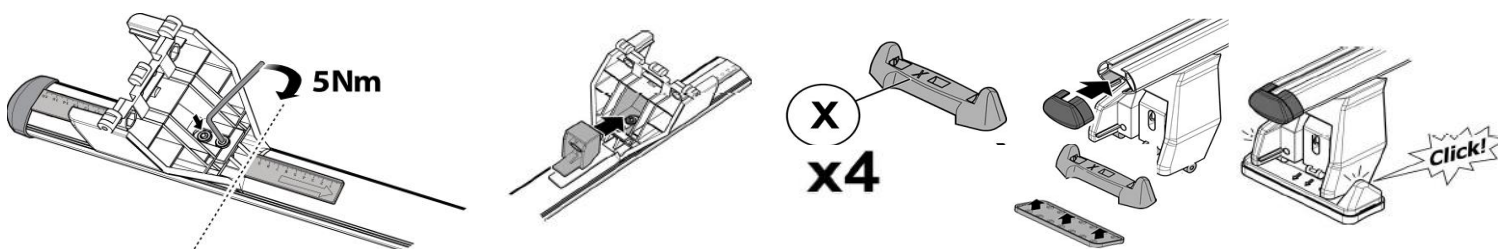

x4

5

(Front)

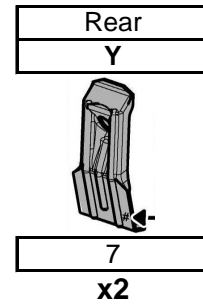
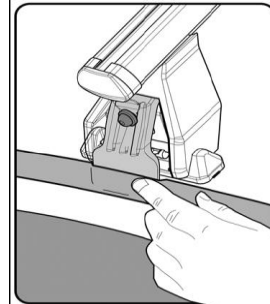
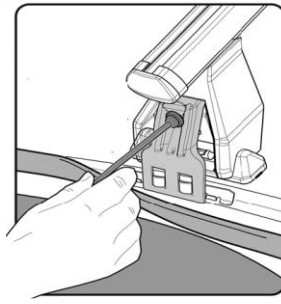
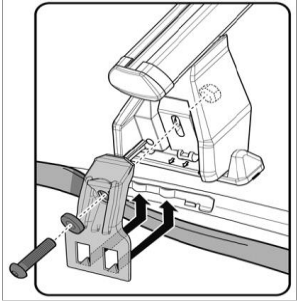
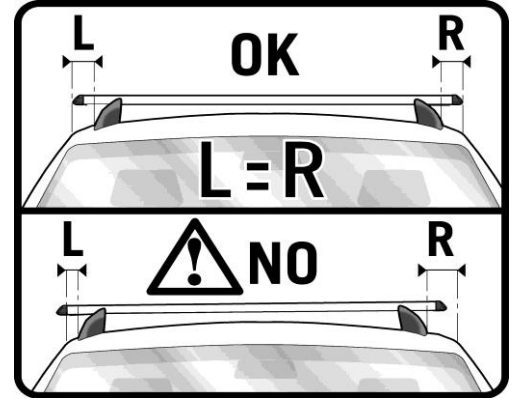
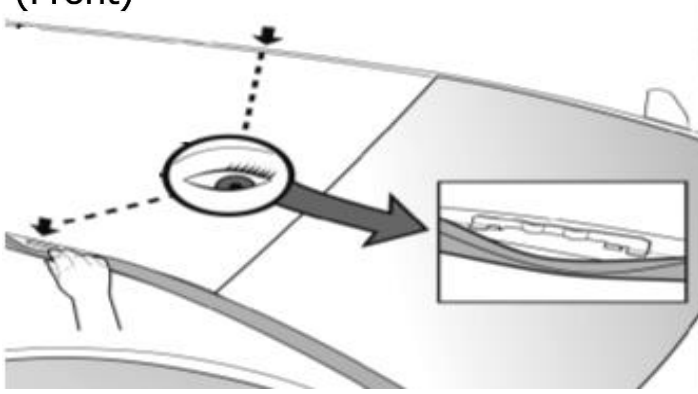

X2

6

(Rear)

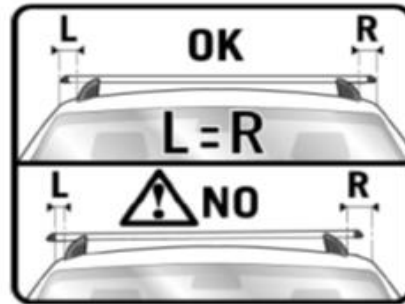

X2

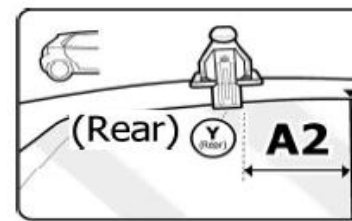
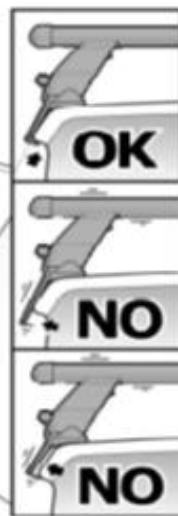
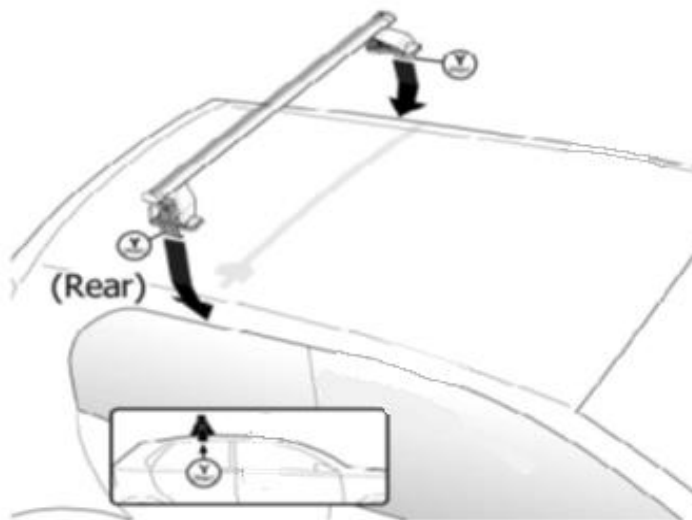
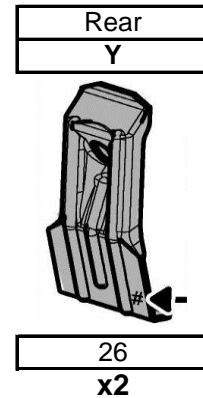

OR

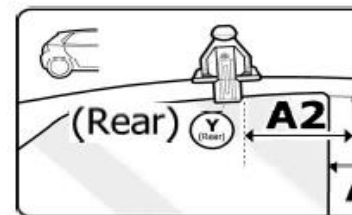

MANUFACTURER	MODEL CAR	DOORS	MODEL YEAR	A1	A2	A1	A2
				cm	cm	in	in
FIAT	Punto I	3	93>99		X		X

X = predisposizione originale /original arrangement