

MANUFACTURER	MODEL CAR	DOORS	MODEL YEAR	D1	D2
ALFA ROMEO	147	5	00>10	9,2	8,8
BMW	Serie 5 (E61) Touring	5	03>10	6,3	6,3
BMW	Serie 5 (G31) Touring		17>	7,2	6,4
BMW	X1 (F48)	5	19>	10,6	10,2
BMW	X2 (F39)	5	18>	13,9	12,0
BMW	X5 (F15)	5	13>18	13,5	12,0
BMW	X5 (G05)	5	19>	13,5	12,0
CHERY	Tiggo 3x / Tiggo 2	5	16>	6,0	6,0
CHRYSLER	300 C	4	05>14	10,4	10,0
CUPRA	Leon IV (MK4) (No tetto in vetro / No glass sunroof)	5	20>	6,8	5,0
DAIHATSU	Cuore	5	07>	10,1	10,6
DR	dr 3	5	16>	6,0	6,0
FIAT	Grande Punto	5	05>12	9,6	8,5
FIAT	Panda III	5	12>	6,4	3,9
FIAT	Punto Evo	5	09>12	9,9	8,5
FIAT	Punto III	5	12>18	9,9	8,5
FORD	Focus II Station Wagon (No Fix Point)	5	04>11	9,0	7,3
GREAT WALL	Hover	5	06>12	11,0	7,9
JAGUAR	I-Pace	5	18>	9,7	8,5
JAGUAR	XE	4	15>	6,3	5,8
JAGUAR	XF (X250)	4	08>15	5,9	9,2
JEEP	Renegade (BU)	5	14>	14,0	14,0
KIA	Sonic	5	17>	7,4	6,1
LANCIA	Delta III	5	08>15	8,2	5,3
LANCIA	Thema	4	11>14	10,4	10,0
LAND ROVER	Discovery Sport II	5	19>	11,5	11,5
MAHINDRA	KUV 100	5	16>	10,7	10,1
MAZDA	Cx-30	5	19>	10,3	7,8
MERCEDES	GLC (X253)	5	15>20	8,8	7,5
MVM	X22	5	16>	6,0	6,0
NISSAN	Juke (F15)	5	10>19	4,4	3,3
NISSAN	Micra / March (K13)	5	10>17	9,6	8,0
NISSAN	Qashqai / Dualis (J11)	5	14>17	11,6	10,0
OPEL / VAUXHALL	Grandland X	5	17>	10,1	8,4
OPEL / VAUXHALL	Insignia	4	09>17	8,3	7,1
PEUGEOT	208	5	12>15	13,0	13,0
PEUGEOT	508 Station Wagon	5	10>18	7,3	5,1
RENAULT	Koleos	5	08>16	10,9	9,6
RENAULT	Laguna III	4	08>	3,8	5,8
SEAT	Leon IV (MK4) (No tetto in vetro / No glass sunroof)	5	20>	6,8	5,0
SEAT	Tarraco	5	18>	11,0	7,9
SKODA	Fabia III (NJ) Wagon / Break		15>	13,9	15,0
SKODA	Octavia II (1Z)	5	08>13	3,3	3,3
SKODA	Rapid (NH1)	4	12>	5,9	5,9
SSANGYONG	Rexton Sport (Y400) / Musso (Q200)	4	18>	14,2	14,2
SUBARU	Pleo	5	07>	10,1	10,6
VOLKSWAGEN	Passat (B8) Alltrack	5	19>	8,9	8,2
VOLKSWAGEN	T-Cross (1C)	5	18>	9,7	9,2
VOLKSWAGEN	Touareg III	5	18>	14,0	12,0

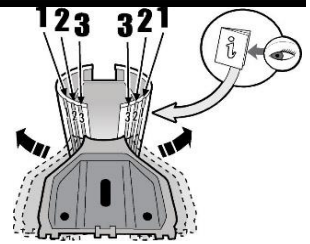
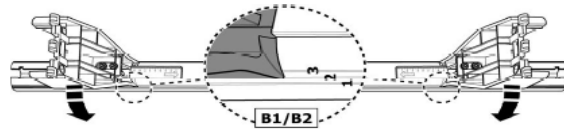
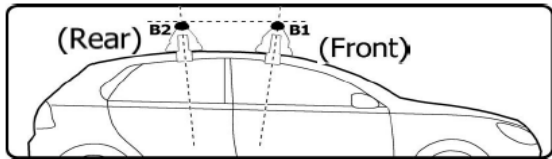
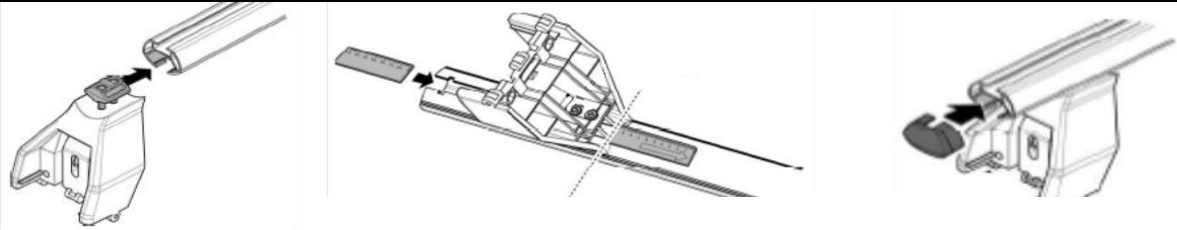

MANUFACTURER	MODEL CAR	DOORS	MODEL YEAR	B1	B2
ALFA ROMEO	147	5	00>10	2	2
BMW	Serie 5 (E61) Touring	5	03>10	2	2
BMW	Serie 5 (G31) Touring		17>	1	2
BMW	X1 (F48)	5	19>	2	2
BMW	X2 (F39)	5	18>	2	2
BMW	X5 (F15)	5	13>18	2	2
BMW	X5 (G05)	5	19>	2	2
CHERY	Tiggo 3x / Tiggo 2	5	16>	1	2
CHRYSLER	300 C	4	05>14	2	2
CUPRA	Leon IV (MK4) (No tetto in vetro / No glass sunroof)	5	20>	2	2
DAIHATSU	Cuore	5	07>	1	2
DR	dr 3	5	16>	1	2
FIAT	Grande Punto	5	05>12	1	2
FIAT	Panda III	5	12>	2	2
FIAT	Punto Evo	5	09>12	1	2
FIAT	Punto III	5	12>18	1	2
FORD	Focus II Station Wagon (No Fix Point)	5	04>11	1	2
GREAT WALL	Hover	5	06>12	2	2
JAGUAR	I-Pace	5	18>	2	2
JAGUAR	XE	4	15>	1	3
JAGUAR	XF (X250)	4	08>15	2	1
JEEP	Renegade (BU)	5	14>	2	2
KIA	Stonic	5	17>	2	2
LANCIA	Delta III	5	08>15	1	2
LANCIA	Thema	4	11>14	2	2
LAND ROVER	Discovery Sport II	5	19>	2	2
MAHINDRA	KUV 100	5	16>	1	2
MAZDA	Cx-30	5	19>	1	2
MERCEDES	GLC (X253)	5	15>20	2	2
MVM	X22	5	16>	1	2
NISSAN	Juke (F15)	5	10>19	2	2
NISSAN	Micra / March (K13)	5	10>17	1	2
NISSAN	Qashqai / Dualis (J11)	5	14>17	2	2
OPEL / VAUXHALL	Grandland X	5	17>	2	2
OPEL / VAUXHALL	Insignia	4	09>17	1	1
PEUGEOT	208	5	12>15	2	1
PEUGEOT	508 Station Wagon	5	10>18	2	1
RENAULT	Koleos	5	08>16	2	2
RENAULT	Laguna III	4	08>	2	2
SEAT	Leon IV (MK4) (No tetto in vetro / No glass sunroof)	5	20>	2	2
SEAT	Tarraco	5	18>	1	2
SKODA	Fabia III (NJ) Wagon / Break		15>	1	2
SKODA	Octavia II (1Z)	5	08>13	2	1
SKODA	Rapid (NH1)	4	12>	1	2
SSANGYONG	Rexton Sport (Y400) / Musso (Q200)	4	18>	2	2
SUBARU	Pleo	5	07>	1	2

VOLKSWAGEN	Passat (B8) Alltrack	5	19>	2	2
VOLKSWAGEN	T-Cross (1C)	5	18>	2	2
VOLKSWAGEN	Touareg III	5	18>	1	2

**4**

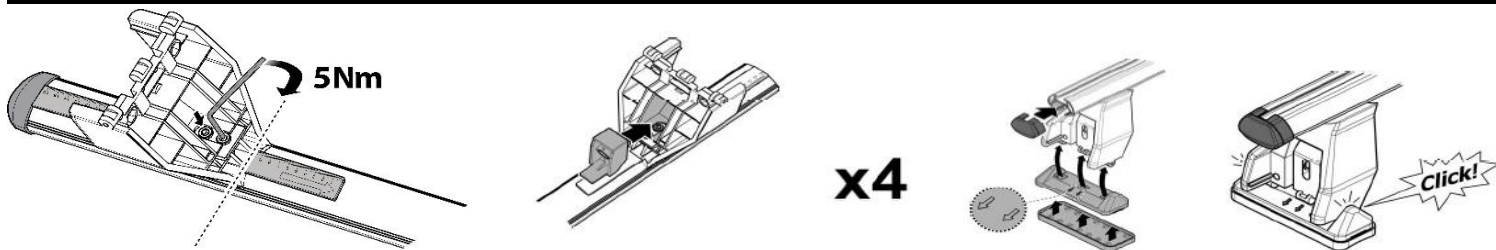

**5**

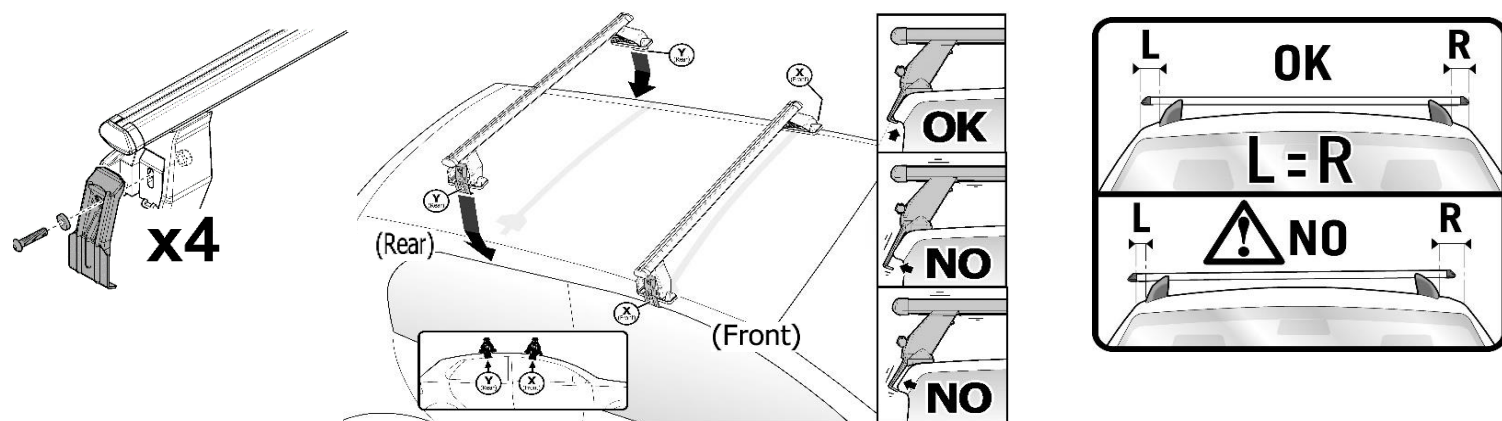

**6**

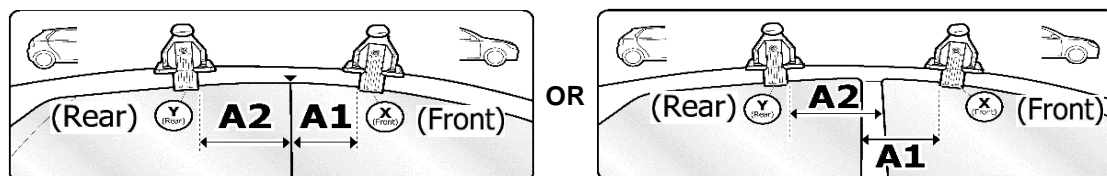

MANUFACTURER	MODEL CAR	DOORS	MODEL YEAR	A1	A2	A1	A2
				cm	cm	in	in
ALFA ROMEO	147	5	00>10	X	X	X	X
BMW	Serie 5 (E61) Touring	5	03>10	22	50	8,7	19,7
BMW	Serie 5 (G31) Touring		17>	23	48	9,1	18,9
BMW	X1 (F48)	5	19>	25	39	9,8	15,4
BMW	X2 (F39)	5	18>	20	50	7,9	19,7
BMW	X5 (F15)	5	13>18	27	41	10,6	16,1
BMW	X5 (G05)	5	19>	27	41	10,6	16,1
CHERY	Tiggo 3x / Tiggo 2	5	16>	17	52	6,7	20,5
CHRYSLER	300 C	4	05>14	33	26	13,0	10,2
CUPRA	Leon IV (MK4) (No tetto in vetro / No glass sunroof)	5	20>	20	46	7,9	18,1
DAIHATSU	Cuore	5	07>	30	42	11,8	16,5
DR	dr 3	5	16>	17	52	6,7	20,5
FIAT	Grande Punto	5	05>12	27	42	10,6	16,5
FIAT	Panda III	5	12>	16	44	6,3	17,3
FIAT	Punto Evo	5	09>12	27	42	10,6	16,5
FIAT	Punto III	5	12>18	27	42	10,6	16,5
FORD	Focus II Station Wagon (No Fix Point)	5	04>11	27	40	10,6	15,7
GREAT WALL	Hover	5	06>12	20	41	7,9	16,1
JAGUAR	I-Pace	5	18>	29	36	11,4	14,2
JAGUAR	XE	4	15>	25	30	9,8	11,8
JAGUAR	XF (X250)	4	08>15	15	48	5,9	18,9
JEEP	Renegade (BU)	5	14>	33	47	13,0	18,5
KIA	Stonic	5	17>	12	48	4,7	18,9

X = predisposizione originale /original arrangement

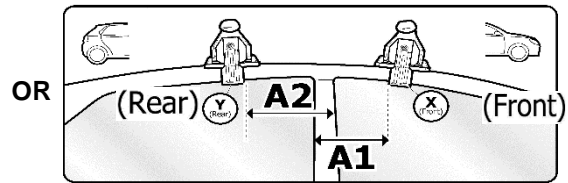
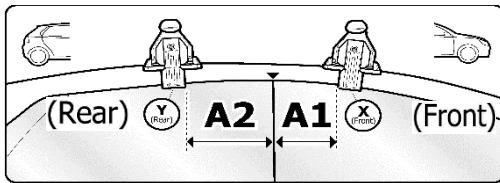

MANUFACTURER	MODEL CAR	DOORS	MODEL YEAR	A1	A2	A1	A2
				cm	cm	in	in
LANCIA	Delta III	5	08>15	27	51	10,6	20,1
LANCIA	Thema	4	11>14	33	26	13,0	10,2
LAND ROVER	Discovery Sport II	5	19>	23	43	9,1	16,9
MAHINDRA	KUV 100	5	16>	25	40	9,8	15,7
MAZDA	Cx-30	5	19>	23	41	9,1	16,1
MERCEDES	GLC (X253)	5	15>20	22	45	8,7	17,7
MVM	X22	5	16>	17	52	6,7	20,5
NISSAN	Juke (F15)	5	10>19	25	36	9,8	14,2
NISSAN	Micra / March (K13)	5	10>17	29	34	11,4	13,4
NISSAN	Qashqai / Dualis (J11)	5	14>17	35	34	13,8	13,4
OPEL / VAUXHALL	Grandland X	5	17>	21	43	8,3	16,9
OPEL / VAUXHALL	Insignia	4	09>17	29	X	11,4	X
PEUGEOT	208	5	12>15	22	42	8,7	16,5
PEUGEOT	508 Station Wagon	5	10>18	21	48	8,3	18,9
RENAULT	Koleos	5	08>16	11	43	4,3	16,9
RENAULT	Laguna III	4	08>	24	42	9,4	16,5
SEAT	Leon IV (MK4) (No tetto in vetro / No glass sunroof)	5	20>	20	46	7,9	18,1
SEAT	Tarraco	5	18>	17	51	6,7	20,1
SKODA	Fabia III (NJ) Wagon / Break		15>	23	42	9,1	16,5
SKODA	Octavia II (1Z)	5	08>13	X	X	X	X
SKODA	Rapid (NH1)	4	12>	22	35	8,7	13,8
SSANGYONG	Rexton Sport (Y400) / Musso (Q200)	4	18>	17	50	6,7	19,7
SUBARU	Pleo	5	07>	30	42	11,8	16,5
VOLKSWAGEN	Passat (B8) Alltrack	5	19>	18	50	7,1	19,7
VOLKSWAGEN	T-Cross (1C)	5	18>	15	49	5,9	19,3
VOLKSWAGEN	Touareg III	5	18>	23	48	9,1	18,9

**X** = predisposizione originale /original arrangement